



BOARD & BATTEN QUICK START INSTALLATION GUIDE

IMPORTANT: Failure to follow Alside written installation instructions and comply with applicable building codes may violate laws and affect siding performance and warranty coverage.

ASCEND serves as a supplemental rain screen, not a weather-resistant barrier. ASCEND must be installed over a weather-resistant barrier system in accordance with local building code.

For complete installation instructions, visit ASCENDCompositeCladding.com.

TOOLS AND BLADES

PANEL CUTS

- Circular saw with a diamond blade or fine tooth (plywood) blade installed backward.
- Angle grinder with diamond blade.
- Tin snips: avoid closing blade completely at end of each stroke for a cleaner cut.

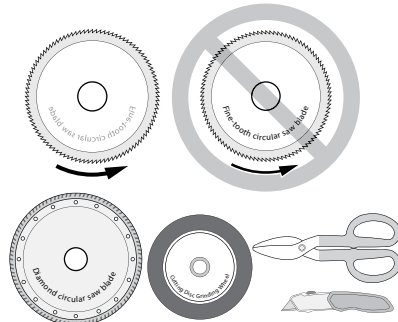

FASTENING

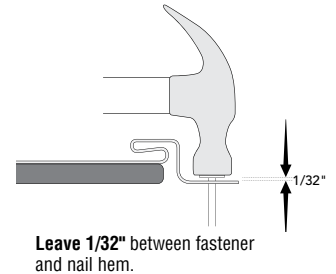

WALL INSTALLATION

Hang ASCEND Board & Batten panel by placing the first fastener in the uppermost part of top full slot. Place all other fasteners in center of nail slots, every 8" to 12" on center. DO NOT fasten through nailing flanges of other materials.



Fasten at the top uppermost unobstructed nail slot on the panel towards the top of the wall. DO NOT fasten through nailing flanges or any other accessories.

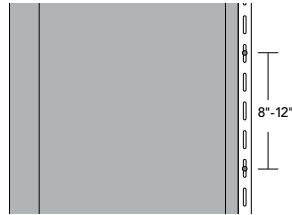

Continue fastening panel every 8" to 12" in center of nailing slot

Maintain a **1/4" clearance** between Board & Batten panel and **top** accessory channel.

Maintain a **1/2" clearance** between Board & Batten panel and **bottom** channel.

ACCESSORY INSTALLATION – RECEIVING CHANNELS

Use minimum 3/4" x 3/4" receiving channel accessories at bottom and top of wall, transitions, corners, windows, doors and other obstacles.

A channeled accessory (such as J-channel) is required to frame the bottom of Board & Batten panels at the bottom of a wall.

IMPORTANT: For water management, drill minimum 3/16" diameter weep holes every 12" to 24" in the base of horizontally installed J-channel. Leave a gap between the J-channel and flashing.

CLEARANCE BETWEEN PANEL AND RECEIVING CHANNELS

Allow gap between panels and channeled accessories:

Maintain a **1/4" clearance** between Board & Batten panel and **top** accessory channel.

Maintain a **1/2" clearance** between Board & Batten panel and **bottom** channel.

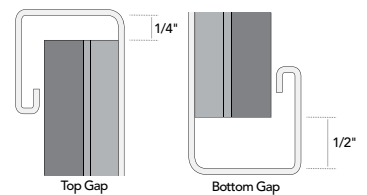

PANEL RIP CUTS

Insert finish trim into corner or obstacle receiving channel. Finish trim is required at vertical receiving channels greater than 12" and will secure the rip cut board section of the panel.

- DO NOT use ASCEND finish trim in horizontal receiving channels.
- If Batten portion of panel (3/4" projection section) is inserted into receiving channel, finish trim is not required.

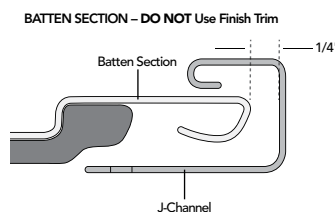
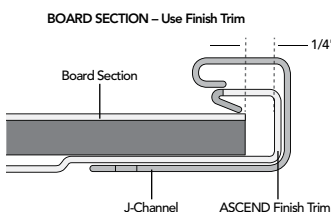

WALL / GABLE LAYOUT – Please refer to full installation guide for a step by step measurement process to produce a balanced wall.

Before cutting and fastening a panel, plan the wall layout to have a balanced look and batten centered in the peak if installing in a gable. A balanced look will have an equal number of full panels to the right and left of the center point of a wall and end pieces will be the same width.

In cases when a partial panel (nail hem is removed) is the last piece of the wall layout, a trim nail can be used to secure panel to wall. Trim nail should be placed at the uppermost point of the panel.

- Pre-drill a 1/8" pilot hole into the board section of plank that will be covered by the receiving channel for trim nail installation.
- Using a trim nail punch, fasten trim nail at top of panel, DO NOT hard nail.

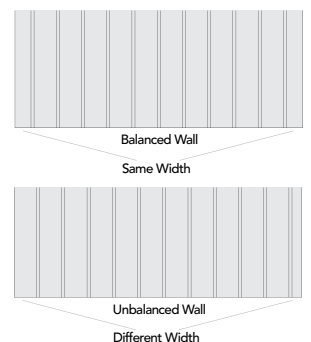

Alside 3773 State Road Cuyahoga Falls, Ohio 44223
1-800-922-6009 www.alside.com

