



7" PLANK QUICK START INSTALLATION GUIDE



Scan here for full installation instructions

IMPORTANT: Failure to follow ASCEND written installation instructions and comply with applicable building codes may violate laws and affect siding performance and void warranty coverage.

ASCEND serves as a supplemental rain screen, not a weather-resistant barrier. ASCEND must be installed over a weather-resistant barrier system in accordance with local building code.

For complete installation instructions, visit ASCENDCompositeCladding.com.

STARTER STRIP

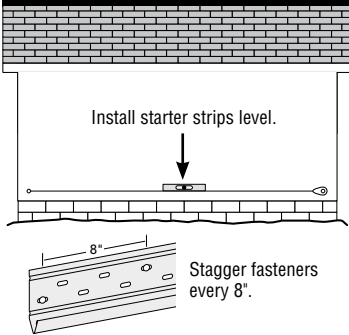

OUTSIDE CORNER POST

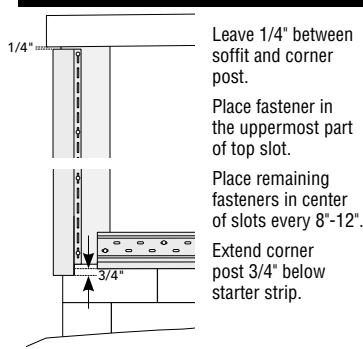

TOOLS AND BLADES

VERTICAL CUTS [IMPORTANT]: Must be straight. Circular saw with a diamond blade or fine tooth (plywood) blade installed backward.

Tin snips; avoid closing blade completely at end of each stroke for a cleaner cut.

HORIZONTAL CUTS
Angle grinder with grinder blade.

Utility knife or scoring tool; score across and through the face of plank, into foam backing, and snap in half.

ANGLE CUTS
Saws, snips and grinder blades are acceptable.

FASTENING – LOWER COURSE AT OVERLAP

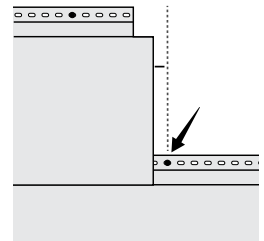

Place a fastener on lower course in nail slot closest to plank overlap. **[IMPORTANT]:** See full installation instructions for further details.

PLANK OVERLAP

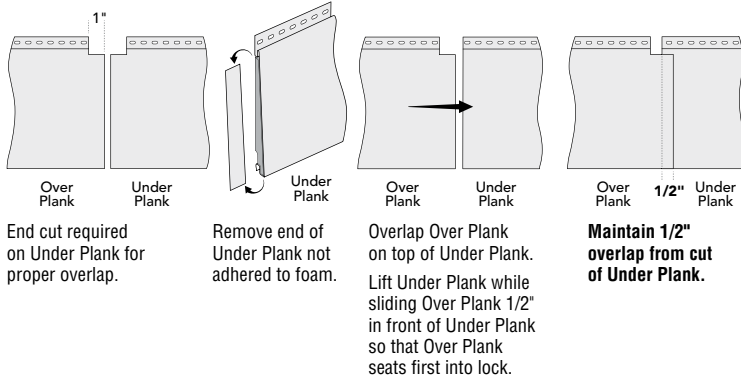

CLEARANCE BETWEEN PLANK AND RECEIVING CHANNELS

Allow gap between planks and channeled accessories:

Ensure 3/8" gap between planks and all channeled accessories or obstacles.

Remove end of plank not adhered to foam before inserting into channel.

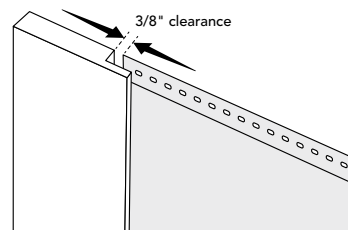

FASTENING

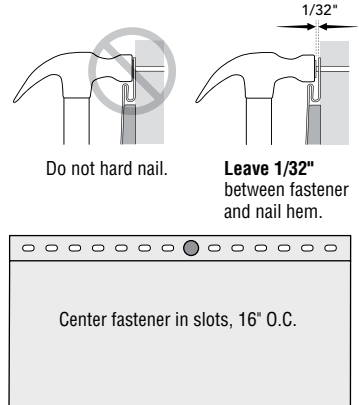

STACK LOCK ENGAGEMENT

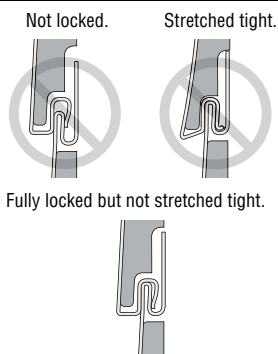

PLANK RIP CUTS BELOW OBSTACLES

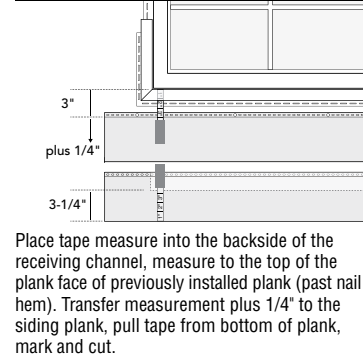

PLANK RIP CUTS ABOVE OBSTACLES

Hook tape measure onto the backside of the receiving channel, measure to the top of the plank face (past nail hem) of previously installed plank. Transfer measurement plus 3/4" to the siding plank, pull tape from bottom of plank, mark and cut.

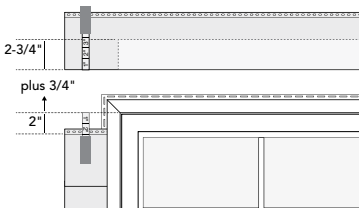

FINISH TRIM – SECURING PLANK RIP CUTS

Use anytime the top nail hem or bottom stack lock of plank has been removed.

Insert into the sill and header receiving channel.

Receiving channel is installed prior to finish trim and measurements for plank cuts.

